

Application

Widely used in residential and shutter applications.

To cover any width of opening, any number of panels can be used.

To accommodate different building designs, panels can slide to one or both sides.

Where panels are fitted externally, a canopy is recommended.

Panel Specification

Track System:	Single Run 100
For Individual Panels:	
Max Panel Height	3000mm
Max Panel Weight	100kg
Min Panel Thickness	28mm

For ease of operation it is recommended that the panel width should not exceed 75% of panel height.

Timber panels for interior use can be of flush construction or glazed. Timber panels for industrial applications should be framed, ledged and braced. Metal panels should be constructed of box section, channel or angle framing, well braced and clad with flat or corrugated sheets.

Standard Sets and Packs

Sets comprise of top track, hangers, clip stops, nylon guides and timber screws.

Set No.	Max. Panel Width	Track Length	Material
SR100-20/1	950mm	2000mm	Chrome bearings, mill track
SR100SS-20/1	950mm	2000mm	SS bearings, anodised track
SR100-30/1	1450mm	3000mm	Chrome bearings, mill track
SR100SS-30/1	1450mm	3000mm	SS bearings, anodised track

Pack No.	Description
SR100-1PK	Fitting pack only, no track
SR100SS-1PK	Fitting pack only, no track, SS bearings

Hardware Specification

Track:	100
Material	Aluminium
Finish	Mill or clear anodised
Standard lengths	2000mm, 3000mm, 4000mm and 6000mm

Brackets:	
Face fitted stainless steel, angle	91
Double face fitted bracket SS	5SS/120
Fit at 400mm maximum centres	

Hangers (2 per panel):		Stainless Option
Timber panels - plate (surface)	57DN	57SS/DN
Timber panels - plate (flush)	58DN	58SS/DN

Hangers supplied with fixing plate and nylon tyred precision bearings. Vertical adjustment is simple and positive. Nylon tyre wheel hangers should not be used on installations involving temperatures exceeding 80°C.

Guides:	
Timber panels - SS plate (94 channels)	106E/94
Timber panels - SS plate (96W channel)	106SSMF
Timber panels - nylon guide	101N
Multiple panels	102W/94SS

Channels:	
Aluminium & Polypropylene	94PPA Mill or clear anodised
Aluminium	94A Mill or clear anodised
	96W Clear anodised
Brass	94B
Standard lengths	2000mm, 3000mm, 4000mm and 6000mm

Accessories:	
Soft Close	100SCT
Clip Stop	100CS
Flush Pulls	401
Flush Bolts	456
Flush bolts and flush pulls are available in (PVDB) PVD Brass, (SN) Satin Nickel & (PN) Polished Nickel	

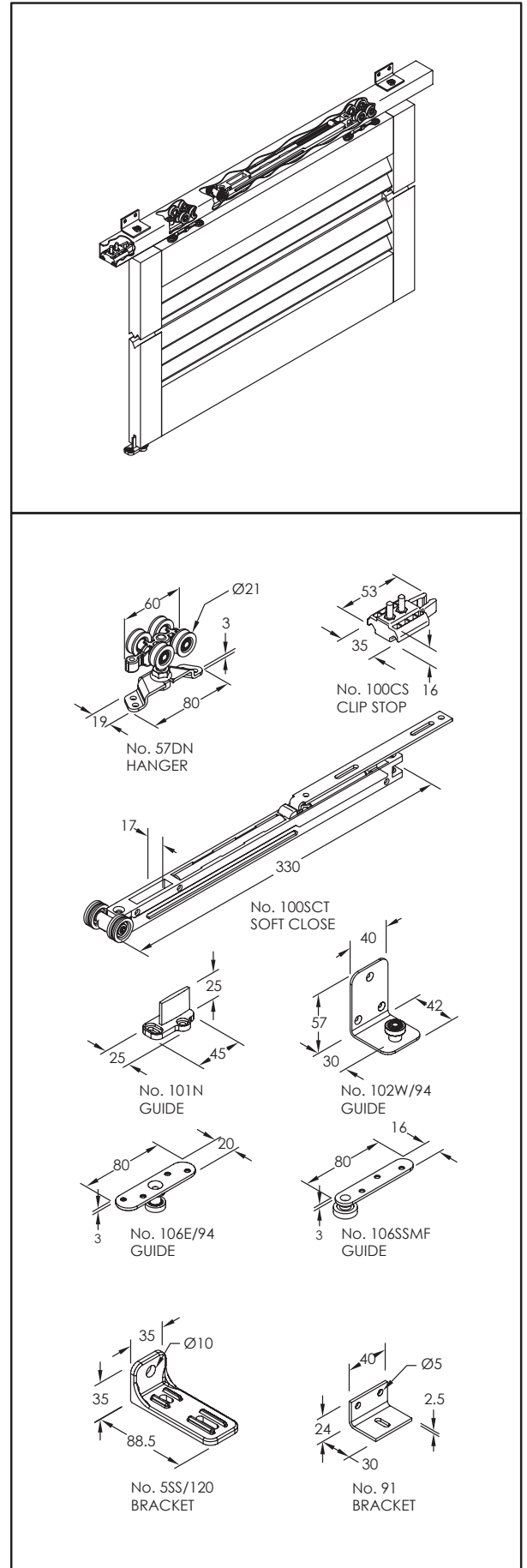

TRACK FIXING CENTRES
20mm FROM EACH END, 400mm MAXIMUM SPACINGS

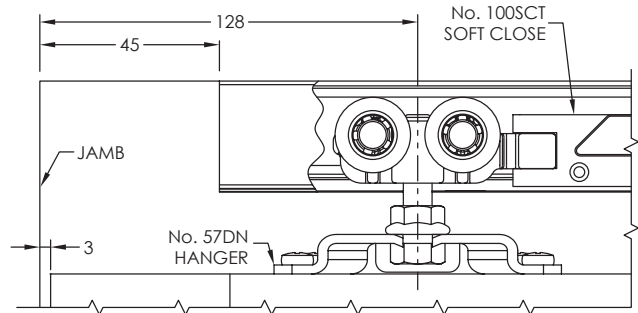
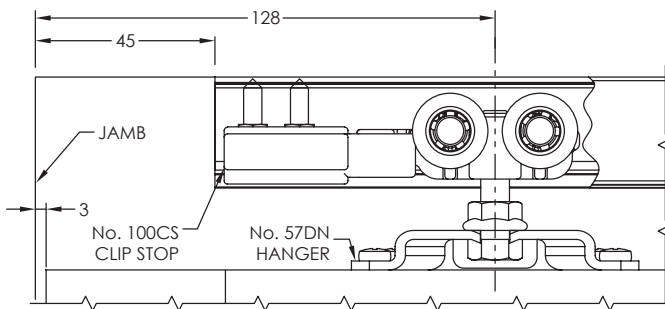

620 MIN PANEL WIDTH SINGLE SOFT CLOSE
970 MIN PANEL WIDTH FOR DOUBLE SOFT CLOSE

PANEL PREPARATION

No. 57ENP HANGER

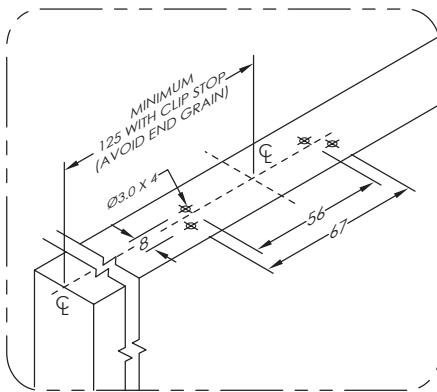

HANGER ASSEMBLY

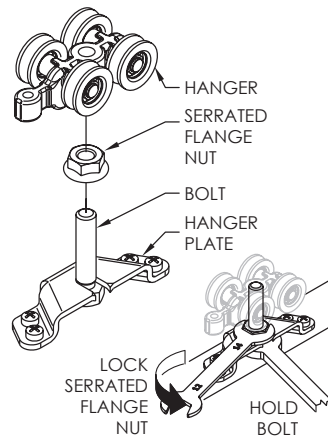

GUIDE OPTIONS

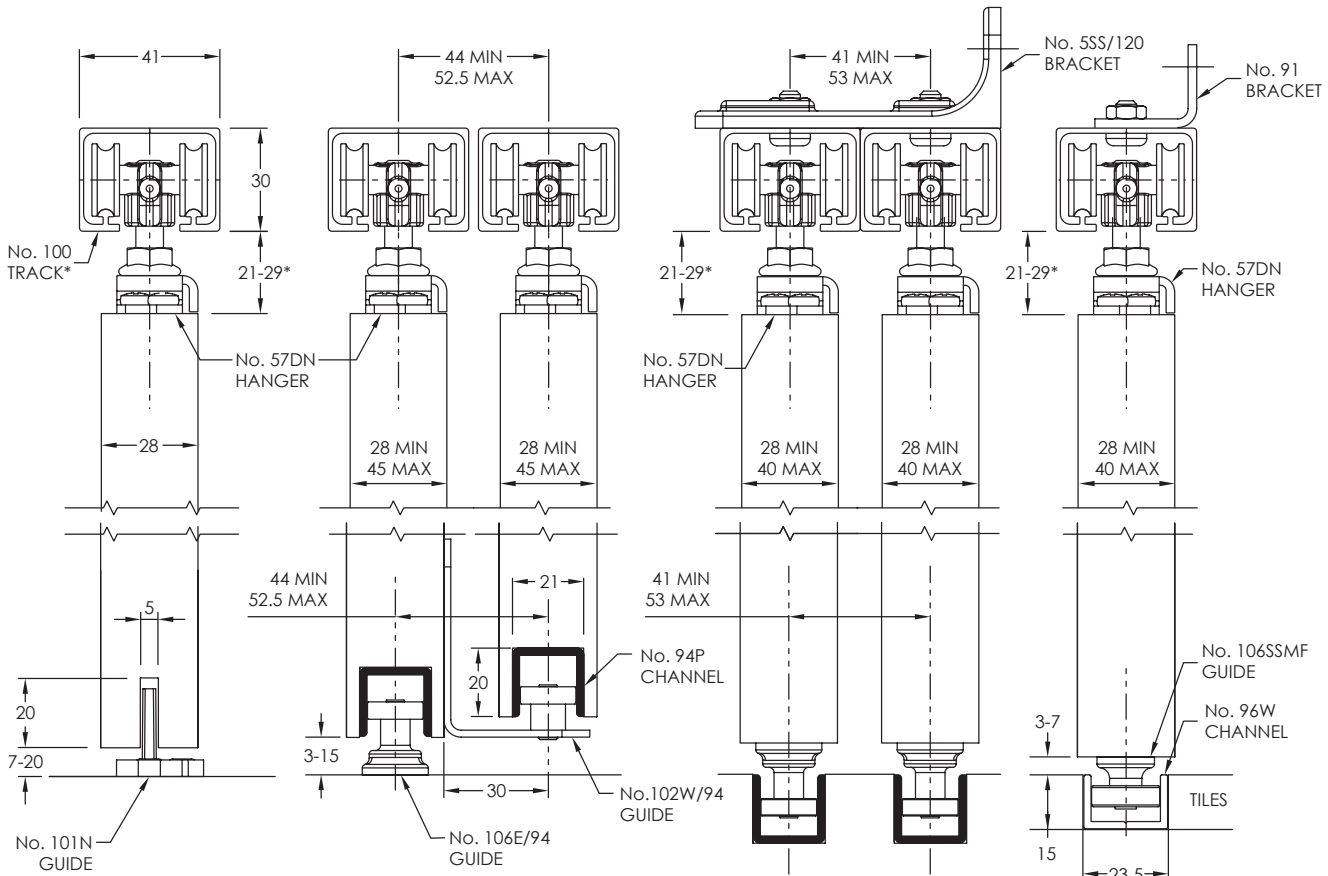
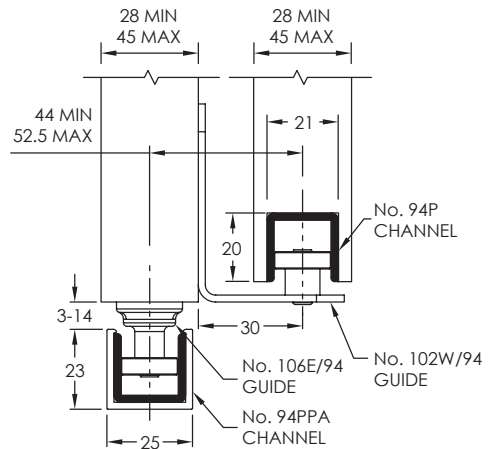

* WHEN USING No. 100SCT SOFT CLOSE:
1. CLEARANCE 24-29
2. No. 100 TRACK TO BE USED WITH AN ANODISED FINISH ONLY