

Brio® Shutterfold 25, Screenfold 25 & Louvrefold 25 - Guide to Quantities

For Top Hung Exterior Folding Shutters, Screens and Louvred Panels

This Guide to Quantities is only applicable to Data Sheets E40, E50 & E60.

Specifications and Quantities

The specifications below and over leaf detail the maximum and minimum capacities for the track systems recommended. Panels are hinged together to form either one or two units of up to six panels each, with each unit pivoted to one side of the opening. Openings can be covered by units of four or six 'floating' panels which are not hinged to the opening.

If the panel weight is unknown, the weight can be calculated using the chart in Section 'A'. Having calculated the weight, use the information below to select the appropriate track system and quantities for the unit or units required to cover the opening width.

Specification for Individual Panels

Track System	Shutterfold 25	Screenfold 25	Louvrefold 25
Refer to Data Sheet	E40	E50	E60
Max Panel Height	2400mm	2400mm	2400mm
Max Panel Weight	25kg	25kg	25kg
Max Panel Width	900mm	900mm	900mm
Recommended Panel Thickness	35-50mm	19mm	35-50mm
Max Number of Panels	6 each direction	6 each direction	6 each direction

2 Panel Unit

	Quantities	Product Codes		
Track	1	100-A20	100-A20	100-A20
Pivot Set	1	21EPNC	21EPB	21EPB-A
Hinge	3	282SS		
Screen Hinges	2		135SS	135SS
Screen Hinges Handle	1		136SS	136SS
Hanger - End	1	21SS/EN	53SSEN	52EN-A
Guide	1		113RB/94	21ER-A
Flush Bolt - Bottom	1	360E	FFB85SS	FFB85SS
Flush Pull	1	401		
Channel	1		94A-A20	94A-A20

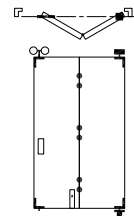

3 Panel Unit

	Quantities	Product Codes		
Track	1	100-A30	100-A30	100-A30
Pivot Set	1	21EP	21EPB	21EPB-A
Hinge	6	282SS		
Screen Hinges	5		135SS	135SS
Screen Hinge Handle	1		136SS	136SS
Hanger - Intermediate	1	21SS/EN	53SS/4EN	52EN/4-A
Guide	1		113RB/94	21ER-A
Flush Bolt - Bottom	1	360E	FFB85SS	FFB85SS
Flush Pull	2	401		
Channel	1	94PPA-A30	94A-A30	94A-A30

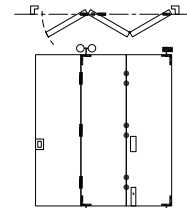

4 Panel Unit

	Quantities	Product Codes		
Track	1	100-A40	100-A40	100-A40
Pivot Set	1	21EP	21EPB	21EPB-A
Hinge	9	282SS		
Screen Hinges	7		135SS	135SS
Screen Hinge Handle	2		136SS	136SS
Hanger - Intermediate	1	21SS/EN	53SS/4EN	53EN/4-A
Hanger - End	1	21SS/EN	53SSEN	52EN-A
Guide	2	106E/94	113RB/94	21ER-A
Flush Bolt - Bottom	2	360E	FFB85SS	FFB85SS
Flush Pull	2	401		
Channel	1	94PPA-A40	94A-A40	94A-A40

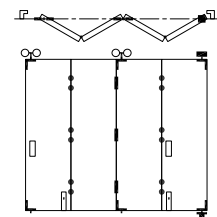

		Shutterfold 25	Screenfold 25	Louvre-fold 25
4 Panel Unit 'Floating'	Quantities	Product Codes		
Track	1	100-A40	100-A40	100-A40
Hinge	9	282SS		
Screen Hinges	7		135SS	135SS
Screen Hinge Handle	2		136SS	136SS
Hanger - Intermediate	1	21SS/EN	53SS/4EN	53EN/4-A
Hanger - End	2	21SS/EN	53SSEN	52EN-A
Guide	3	106E/94	113RB/94	21ER-A
Flush Bolt - Bottom	2	360E	FFB85SS	FFB85SS
Flush Pull	2	401		
Channel	1	94PPA-A40	94A-A40	94A-A40
2+2 Panel Unit	Quantities	Product Codes		
Track	1	100-A40	100-A40	100-A40
Pivot Set	2	21EP	21EPB	21EPB-A
Hinge	6	282SS		
Screen Hinges	4		135SS	135SS
Screen Hinge Handle	2		136SS	136SS
Hanger - End	2	21SS/EN	53SSEN	52EN-A
Guide	2	106E/94	113RB/94	21ER-A
Flush Bolt - Bottom	2	360E	FFB85SS	FFB85SS
Flush Pull	2	401		
Channel	1	94PPA-A40	94A-A40	94A-A40
5 Panel Unit	Quantities	Product Codes		
Track	1	100-A60	100-A60	100-A60
Pivot Set	1	21EP	21EPB	21EPB-A
Hinge	12	282SS		
Screen Hinges	10		135SS	135SS
Screen Hinge Handle	2		136SS	136SS
Hanger - Intermediate	2	21SS/EN	53SS/4EN	53EN/4-A
Guide	2	106E/94	113RB/94	21ER-A
Flush Bolt - Bottom	2	360E	FFB85SS	FFB85SS
Flush Pull	3	401		
Channel	1	94PPA-A60	94A-A60	94A-A60
6 Panel Unit	Quantities	Product Codes		
Track	1	100-A60	100-A60	100-A60
Pivot Set	1	21EP	21EPB	21EPB-A
Hinge	15	282SS		
Screen Hinges	12		135SS	135SS
Screen Hinge Handle	3		136SS	136SS
Hanger - Intermediate	2	21SS/EN	53SS/4EN	53EN/4-A
Hanger - End	1	21SS/EN	53SSEN	52EN-A
Guide	3	106E/94	113RB/94	21ER-A
Flush Bolt - Bottom	3	360E	FFB85SS	FFB85SS
Flush Pull	3	401		
Channel	1	94PPA-A40	94A-A40	94A-A40
6 Panel Unit 'Floating'	Quantities	Product Codes		
Track	1	100-A60	100-A60	100-A60
Hinge	15	282SS		
Screen Hinges	12		135SS	135SS
Screen Hinge Handle	3		136SS	136SS
Hanger - Intermediate	2	21SS/EN	53SS/4EN	53EN/4-A
Hanger - End	2	21SS/EN	53SSEN	52EN-A
Guide	4	106E/94	113RB/94	21ER-A
Flush Bolt - Top	3	360		
Flush Bolt - Bottom	3	360E	FFB85SS	FFB85SS
Flush Pull	3	401		
Channel	1	94PPA-A60	94A-A60	94A-A60

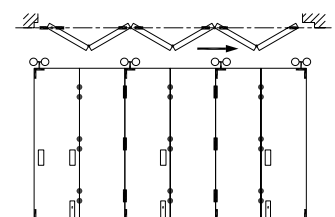
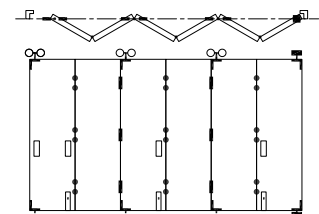
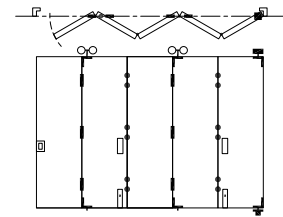
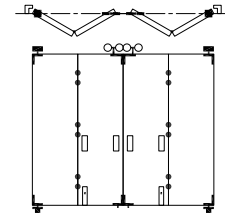
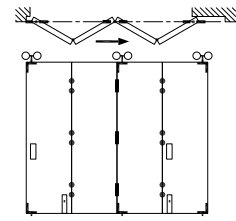

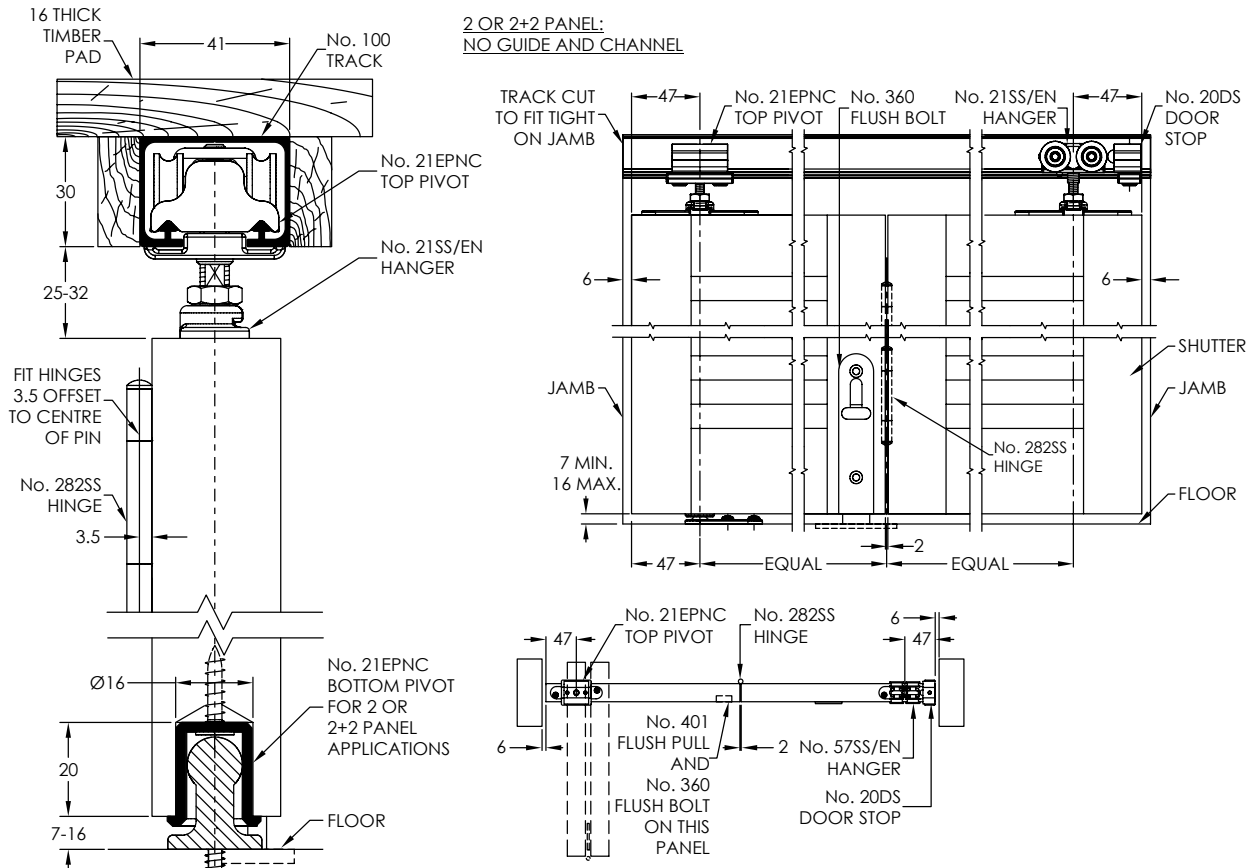

**4 OR MORE PANELS:
GUIDE AND BOTTOM CHANNEL**

**No. 21EP
ADJUSTABLE BOTTOM PIVOT**

