

This Guide to Quantities is only applicable to Data Sheets D80.

Specifications and Quantities

The specifications below and overleaf detail the maximum and minimum capacities for the track systems recommended. Panels are hinged together to form either one or two units of up to eight panels each, with each unit pivoted to one side of the opening. Openings can be covered by units of four, six or eight 'floating' panels. Floating systems must include a guide.

If the panel weight is unknown, the weight can be calculated using the chart in Section 'A'. Having calculated the weight, use the information below to select the appropriate track system and quantities for the unit or units required to cover the opening width.

Specification for Individual Panels

Track System	Pivofold 75
Refer to Data Sheet	D80
Max Panel Height	3300mm
Max Panel Weight	75kg
Max Panel Width	900mm
Min Panel Thickness	40mm
Max Number of Panels	8 each direction

2 Panel Unit Pivoted to one side

	Quantities	Product Codes
Track	See data sheet D75C	250
Bracket (face fix)	See data sheet D75C	1SS/250
Pivot Set	1	21HP/21HP-C
Hanger	1	21HN
Hinges	3*	404/3
Guide (optional)	1	21RB/94
Channel (optional)	See data sheet D75C	94A, 94B, 94P & 94PA
Flush Pulls	2	401
Flush Bolt	1	456

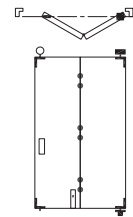

*For Panels exceeding 3000mm high, increase to 4

3 Panel Unit Pivoted to one side

	Quantities	Product Codes
Track	See data sheet D75C	250
Bracket (face fix)	See data sheet D75C	1SS/250
Pivot Set	1	21HP/21HP-C
Hanger	1	21/4HN
Hinges	6	404/3
Guide	1	21RB/94
Channel	See data sheet D75C	94A, 94B, 94P & 94PA
Flush Pulls	1	401
Flush Bolt	1	456

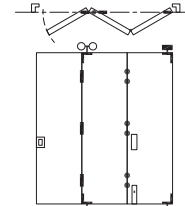

4 Panel Unit Pivoted to one side

	Quantities	Product Codes
Track	See data sheet D75C	250
Bracket (face fix)	See data sheet D75C	1SS/250
Pivot Set	1	21HP/21HP-C
Hangers	1	21HN
Hangers	1	21/4HN
Hinges	9*	404/3
Guides	2	21RB/94
Channel	See data sheet D75C	94A, 94B, 94P & 94PA
Flush Pulls	3	401
Flush Bolts	2	456

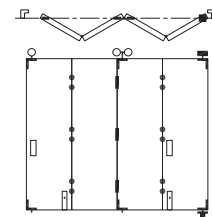

*For Panels exceeding 3000mm high, increase to 12

4 Panel 'Floating' Unit

	Quantities	Product Codes
Track	See data sheet D75C	250
Bracket (face fix)	See data sheet D75C	1SS/250
Hangers	2	21HN
Hangers	1	21/4HN
Hinges	9*	404/3
Guides	3	21RB/94
Channel	See data sheet D75C	94A, 94B, 94P & 94PA
Flush Pulls	3	401
Flush Bolts	2	456

*For Panels exceeding 3000mm high, increase to 12

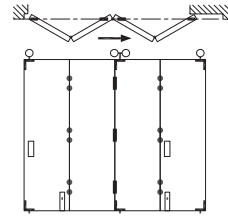

5 Panel Unit Pivoted to one side

	Quantities	Product Codes
Track	See data sheet D75C	250
Bracket (face fix)	See data sheet D75C	1SS/250
Pivot Set	1	21HP/21HP-C
Hanger	2	21/4HN
Hinges	12	404/3
Guides	2	21RB/94
Channel	See data sheet D75C	94A, 94B, 94P & 94PA
Flush Pulls	2	401
Flush Bolts	2	456

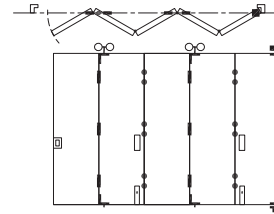

6 Panel Unit Pivoted to one side

	Quantities	Product Codes
Track	See data sheet D75C	250
Bracket (face fix)	See data sheet D75C	1SS/250
Pivot Set	1	21HP/21HP-C
Hangers	2	21/4HN
Hangers	1	21HN
Hinges	15*	404/3
Guides	3	21RB/94
Channel	See data sheet D75C	94A, 94B, 94P & 94PA
Flush Pulls	4	401
Flush Bolts	3	456

*For Panels exceeding 3000mm high, increase to 20

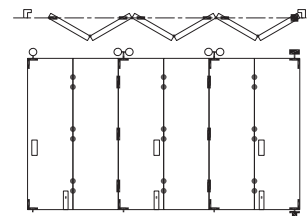

6 Panel 'Floating' Unit

	Quantities	Product Codes
Track	See data sheet D75C	250
Bracket (face fix)	See data sheet D75C	1SS/250
Hangers	2	21/4HN
Hangers	2	21HN
Hinges	15*	404/3
Guides	4	21RB/94
Channel	See data sheet D75C	94A, 94B, 94P & 94PA
Flush Pulls	4	401
Flush Bolts	3	456

*For Panels exceeding 3000mm high, increase to 20

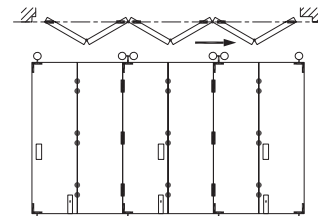

2 Additional Panels to increase 5 or 6 Panel units to 7 or 8 Panel units

	Quantities	Product Codes
Hanger	1	21/4HN
Hinges	6*	404/3
Guide	1	21RB/94
Flush Pull	1	401
Flush Bolt	1	456

*For Panels exceeding 3000mm high, increase to 8

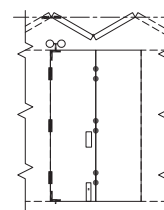

Track, Bracket and Channel Quantities

From the table below, choose the quantities of applicable track, bracket and channel.

Track and Channel

Choose sufficient track and channel to cover the overall opening width. If a 'floating' unit is required to slide clear of the opening, then sufficient track and channel is required to cover the widths of the stacking bay and the opening.

Bracket Spacing (Face Fix)

Place a bracket at 50mm in from both ends on each track, on each track used. Install next bracket 100mm in from the first bracket on the end which panels will pivot from. If using 6 panels or more, install another bracket 100mm in from the second bracket. Then install a bracket at approximately 400mm intervals.

Opening Width	Track Length	Bracket Quantity	Channel lengths
2000 (1 unit of 3 panels)	1 x 2000	7	1 x 2000
3000 (1 unit of 4 panels)	1 x 3000	9	1 x 3000
4000 (1 unit of 6 panels)	1 x 4000	12	1 x 4000
5000 (1 unit of 6 panels)	1 x 5000	15	1 x 5000
6000 (1 unit of 6 panels)	1 x 6000	17	1 x 6000
7000 (1 unit of 8 panels)	1 x 3000 } 1 x 4000 }	20	1 x 3000 } 1 x 4000 }
8000 (2 units of 6 panels)	2 x 4000	24	2 x 4000

If using two units which pivot from both sides of the opening, repeat the 100mm fixing point on both ends of the track

If using floating panels, increase fixing points in location where panels will be stacked in the open position.

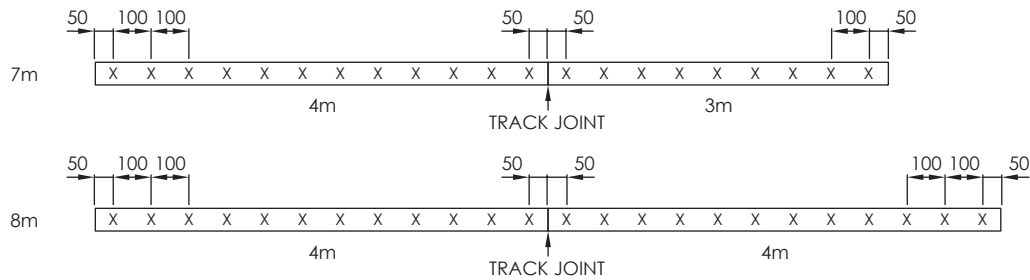

X = BRACKET POSITION APPROX. 400mm SPACINGS UNLESS OTHERWISE SPECIFIED



Application

Suitable for residential and commercial folding partitions using equal size panels.

Panels can fold to one or both sides of the opening.

To cover any width opening, any number of folding units can be used.

Panel Specification

Track System:	Pivofold 75
For Individual Panels:	
Max Panel Height	3300mm
Max Panel Weight	75kg
Max Panel Width	900mm
Min Panel Thickness	40mm

Use Pivofold only if panels must be of equal width. Endfold is preferred because the first panel is hinged to a post. See Data Sheet D110.

The folding unit is pivoted in the track and off the floor. Folding units of up to eight panels can be pivoted to each side of the opening. A pivoted unit with an odd number of panels provides a hinged access door.

A guide system across the floor must be used on units of three panels or more. Floating units consist of four, six or eight panels folding.

Panels should be constructed to provide secure fitting for the pivot sets, hangers, hinges and guides and can be flush, panelled or glazed

Hardware Specification

Track:	250
Material	Aluminium, Mill or Clear Anodised
Standard Lengths	2000mm, 3000mm, 4000mm & 6000mm

Bracket (Face Fix):	
Bracket 316 Stainless Steel	1SS/250
Brackets located close together at the pivot end of the track with other brackets at 400mm centres.	

Hangers:	
End Panels	21HN
Intermediate Panels	21/4HN
Hangers are fitted with nylon tyre wheels on ball race bearings. Vertical adjustment is simple and positive.	

Pivot Set:	
Top and bottom pivots	21HP
Top and bottom pivots for channel	21HP-C

Guide:	
With precision bearings	21RB/94
All steel parts to hangers, pivots and guides are stainless steel	

Hinges:	
Butt hinge	404/2S
Stainless steel hinge, 76x63mm	
Butt hinge	404/3S
Stainless steel hinge, 101x76mm	

Channels:	
Aluminium	94A
Polypropylene & Aluminium	94PPA
Finish	Mill or clear anodised
Brass	94B
Standard Lengths	2000mm, 3000mm, 4000mm and 6000mm

Accessories:	
Flush Pulls	401
Flush Bolts	456
Flush bolts and flush pulls are available in (PVDB) PVD Brass, (SN) Satin Nickel & (PN) Polished Nickel	

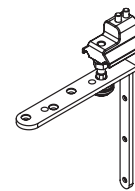
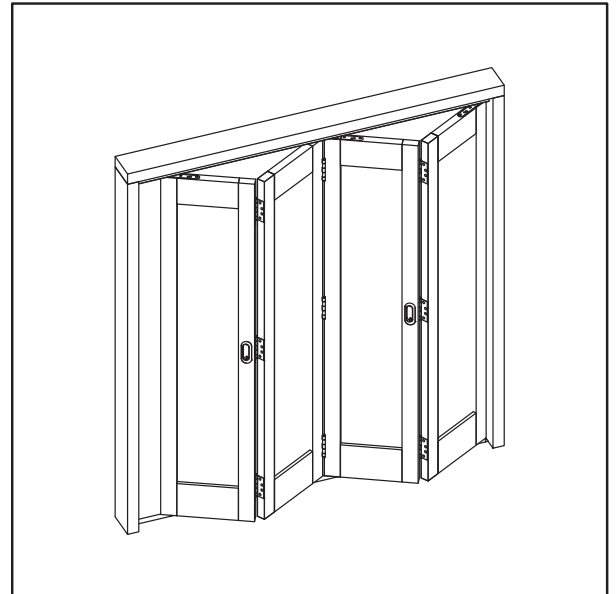

No. 21HP
PIVOT SET
TOP ASSEMBLY

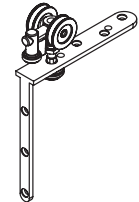

No. 21HN
HANGER

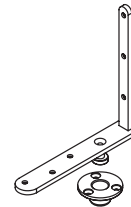

No. 21HP
PIVOT SET
BOTTOM ASSEMBLY

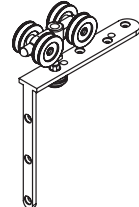

No. 21/4HN
HANGER

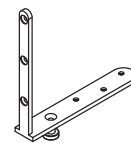

No. 21RB/94
GUIDE

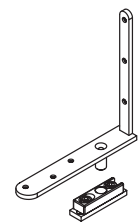

No. 21HP-C
PIVOT SET
BOTTOM ASSEMBLY
FOR CHANNEL

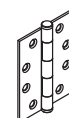

No. 404
BUTT HINGE



No. 401
FLUSH PULL

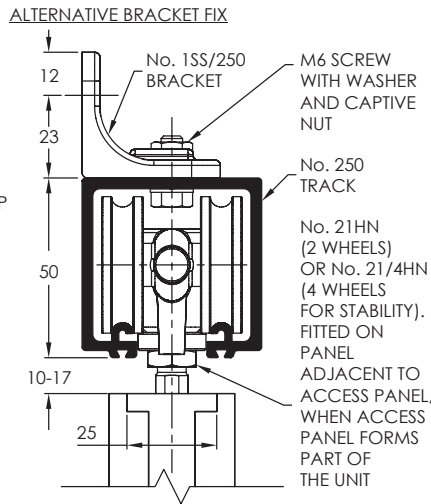
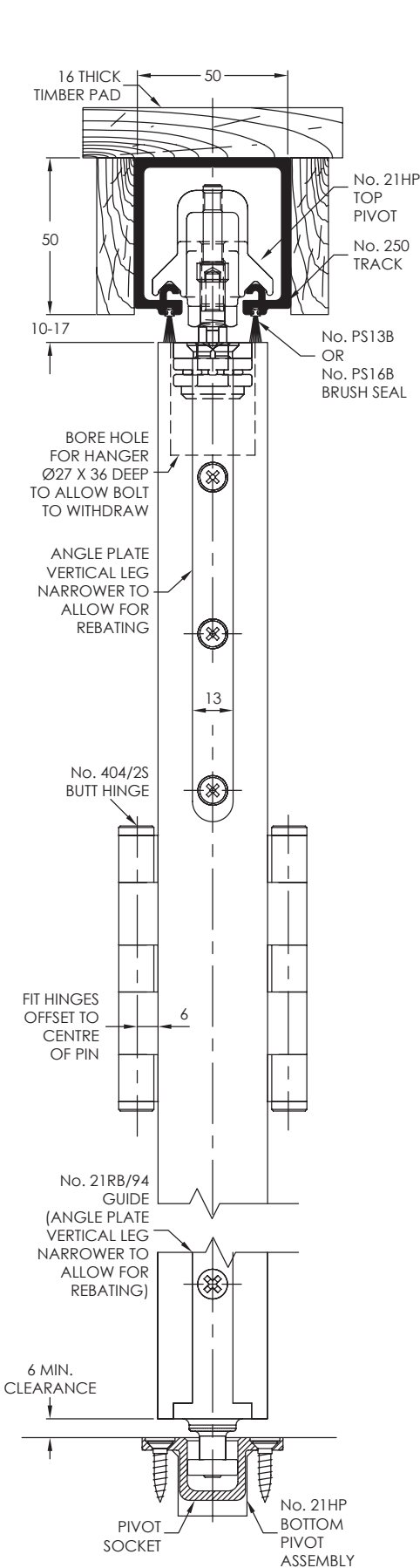

PIVOT DETAIL TOP OF PANEL (HANGER REMOVED)

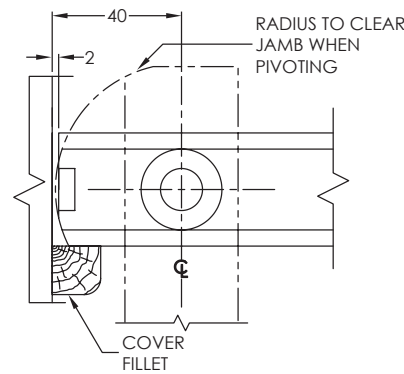

No. 21HP-C BOTTOM PIVOT ASSEMBLY

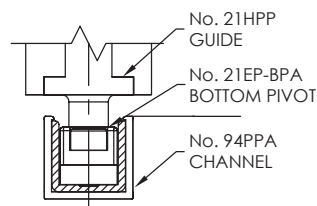

CONFIGURATIONS

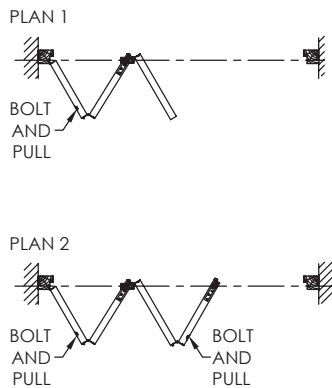

TRACK PREPARATION

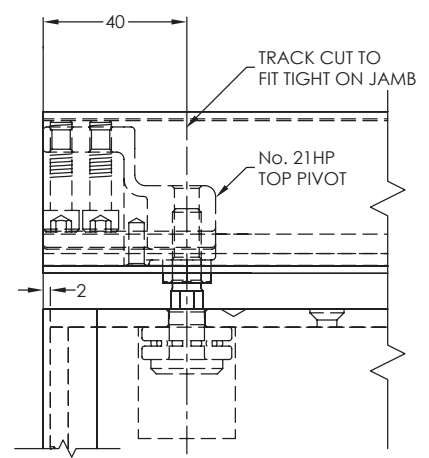

No. 21HP BOTTOM PIVOT ASSEMBLY

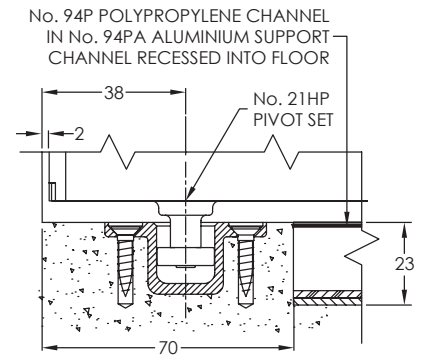

No. 21HP-C BOTTOM PIVOT ASSEMBLY

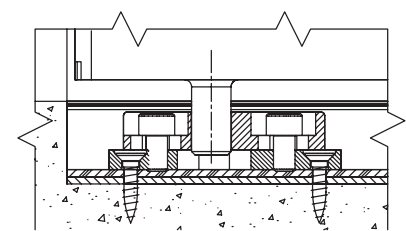

TYPICAL ELEVATION AS PER PLAN 2

