

Application

For timber and aluminium sliding panels, interior and exterior applications.

Designed for straight sliding partitions or fully glazed patio doors. Also suitable for flush panelled construction.

The bottom roller design is suited to applications where the supporting structure or lintel is insufficient for the weight of the panel or where headroom is limited.

To cover the width of opening, any number of panels can be used on single or multiple lines of rail, panels can slide to one or both sides.

Where fitted externally, a canopy is recommended to protect the top guide channel, brackets and top guide rollers.

Panel Specification

Rail System:

For Individual Panels:

Max Panel Height
Max Panel Weight
Min Panel Thickness

Timberoll 300N

3000mm
300kg
40mm

Panels must be constructed with bottom rails of at least 150mm depth to accommodate the concealed, mortised bottom rollers. Panel weight is carried on the floor permitting the use of a light overhead structure.

Hardware Specification

Top Guide Channel:

Medium Duty
Finish
Standard lengths

94PPA Aluminium Support & Polypropylene
Mill or Clear Anodised
2000mm, 3000mm, 4000mm and 6000mm.

Heavy Duty

Finish
Standards Lengths

900A Aluminium with safety lip
Clear Anodised
2000mm, 3000mm, 4000mm and 6000mm.

Top Guide Brackets:

For single line - face fitted
For double line - face fitted

1SS/250 Stainless Steel
5SS/250 Stainless Steel

Constructed from cast 316 Stainless Steel, fit at 400mm maximum centres.

Top Guide Rollers (2 per panel):

Top Plate Fitting
Corner Fitting

106RB/94
113RB/94

Cast 316 Marine grade stainless with precision stainless steel bearings.

Top Plate Fitting 61SS/900 (for 900 Top Guide Channel)

Cast 316 Marine grade stainless plate with double nylon rollers with lateral adjustment to prevent rattle.

Bottom Rollers (2 per panel):

Double bogie roller

913DBA-300N

Full stainless steel body with precision stainless bearing and acetal tyre. End access for vertical adjustment.

Bottom Rail:

Material
Finish
Standard lengths

913A
Aluminium
Clear anodised
2000mm, 3000mm, 4000mm and 6000mm.

Bottom Rail is drilled and countersunk for direct fitting.

Interlocker:

Material
Finish
Standard lengths

924
Aluminium
Clear Anodised (CA), Black Anodised (BLK) and Anodised Bronze (BZ)
4800mm (to suit typical 2400mm high panel)

Interlocker is drilled and countersunk, comes with brush seal.

Accessories:

Door Collector - multiple panels
Flush Bolt
Flush Pull
Frame Seal

924-DC
456
401
AQ21

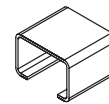

No. 900A
GUIDE CHANNEL

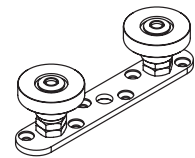

No. 61SS/900
TOP GUIDE ROLLER



No. 94PPA
CHANNEL



No. 113RB/94
GUIDE ROLLER

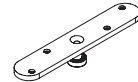

No. 106RB/94
GUIDE ROLLER



No. 913A
BOTTOM RAIL



No. 924-48BZ
INTERLOCKER

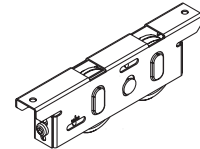

No. 913DBA-300N
BOTTOM ROLLER

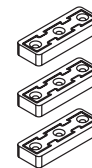

No. 924-DC
DOOR COLLECTOR

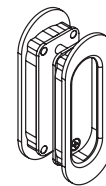

No. 401
FLUSH PULL

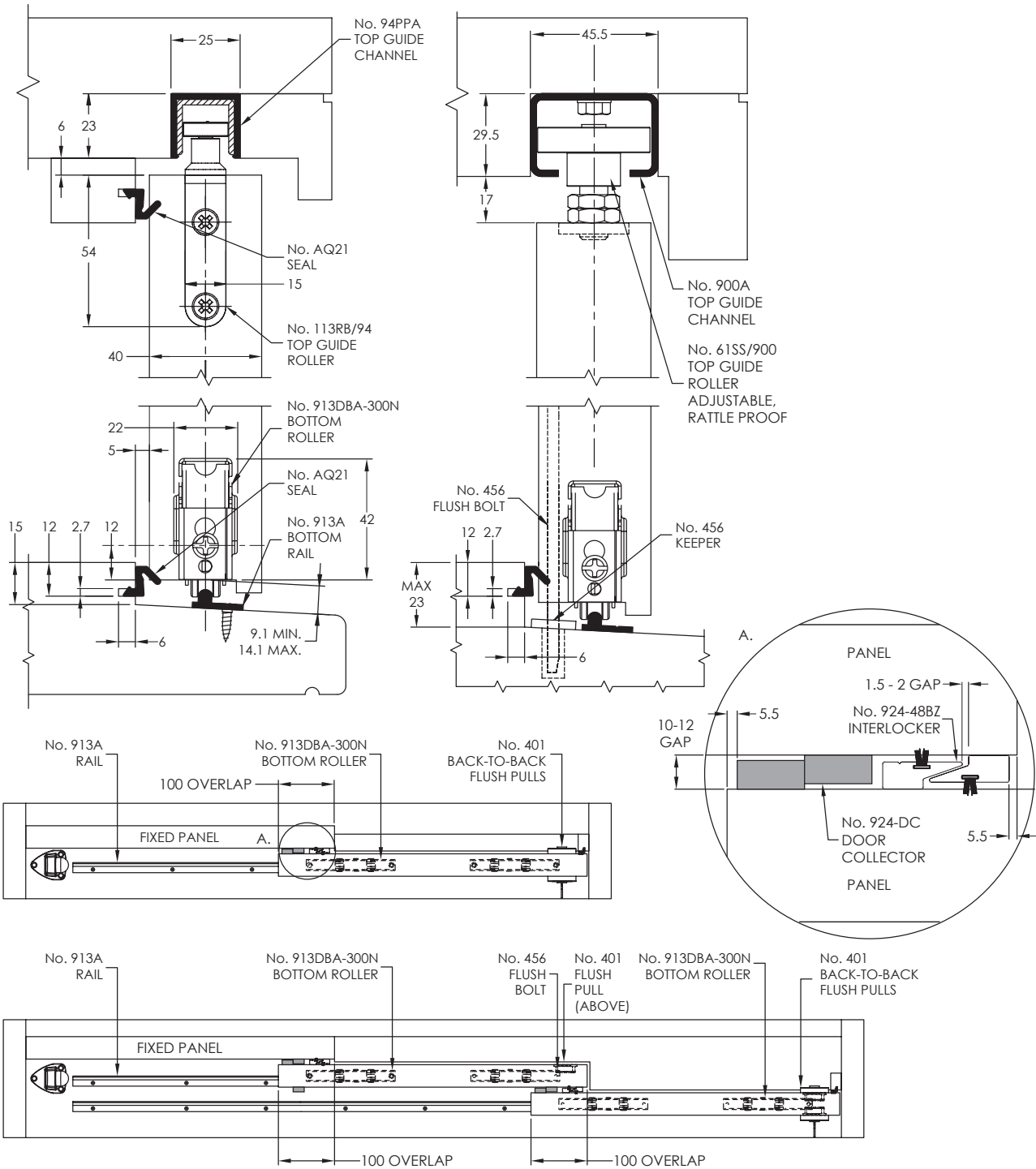

913DBA-300N END ADJUSTABLE ROLLER

