

This Guide to Quantities is only applicable to Data Sheets D150.

### Specifications and Quantities

The specifications below and overleaf detail the maximum and minimum capacities for the track systems recommended. Panels are hinged together to form units of up to five full panels and one half panel hinged to a post. Openings can be covered by units 'floating' to either side of the opening. 'Floating' units consist of up to five full panels and must include a guide.

If the panel weight is unknown, the weight can be calculated using the chart in Section 'A'. Having calculated the weight, use the information below to select the appropriate track system and quantities for the unit or units required to cover the opening width.

#### Specification for Individual Panels

Track System	<b>Centrefold 35</b>
Refer to Data Sheet	D150
Max Panel Height	2400mm
Max Panel Weight	35kg
Max Panel Width	920mm
Min Panel Thickness	35mm or 38mm with Flush Bolts
Max Number of Panels	5 ½ each direction

#### 1 ½ Panel Unit Hinged to Post

	Quantities	Product Codes
Track	See data sheet D130B	100
Bracket (face fix)	See data sheet D130B	1SS/250
Hanger	1	35ENP
Hinges	6	282SS
Guide (optional)	1	106SSMF
Channel (optional)	See data sheet D130B	96W
Flush Pulls	2	401
Flush Bolt	2	456



#### 2 ½ Panel Unit Hinged to Post Inc. Access Door

	Quantities	Product Codes
Track	See data sheet D130B	100
Brackets, (face fix)	See data sheet D130B	1SS/250
Hanger	1	35ENP
Hinges	9	282SS
Guide (optional)	1	106SSMF
Channel (optional)	See data sheet D130B	96W
Flush Pulls	3	401
Flush Bolt	3	456

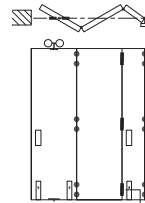

#### 3 ½ Panel Unit Hinged to Post

	Quantities	Product Codes
Track	See data sheet D130B	100
Bracket (face fix)	See data sheet D130B	1SS/250
Hanger	2	35ENP
Hinges	12	282SS
Guide	2	106SSMF
Channel	See data sheet D130B	96W
Flush Pulls	3	401
Flush Bolt	3	456

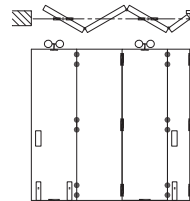

#### 4 ½ Panel Unit hinged to a post Inc. Access Door

	Quantities	Product Codes
Track	See data sheet D130B	100
Bracket (face fix)	See data sheet D130B	1SS/250
Hanger	2	35ENP
Hinges	15	282SS
Guide	2	106SSMF
Channel	See data sheet D130B	96W
Flush Pulls	4	401
Flush Bolts	4	456

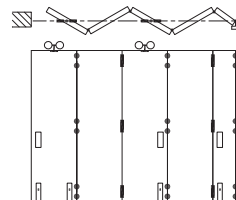

### 5 ½ Panel Unit Hinged to Post

Track	See below	100
Bracket (face fix)	See below	1SS/250
Hanger	3	35ENP
Hinges	18	282SS
Guide	3	106SSMF
Channel	See below	96W
Flush Pulls	4	401
Flush Bolt	4	456

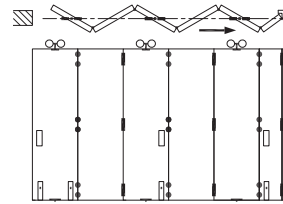

### 2 Additional Panels

	Quantities	Product Codes
Hanger	1	35ENP
Hinges	6*	282SS
Guide	1	106SSMF
Flush Pull	1	401
Flush Bolt	1	456

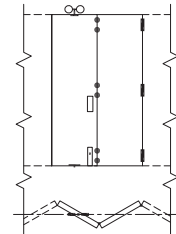

## Track, Bracket and Channel Quantities

From the table below, choose the quantities of applicable track, bracket and channel.

### Track and Channel

Choose sufficient track and channel to cover the overall opening width. If a 'floating' unit is required to slide clear of the opening, then sufficient track and channel is required to cover the widths of the stacking bay and the opening.

### Bracket Spacing (Face Fix)

Place a bracket at 50mm in from both ends on each track, on each track used. Install next bracket 100mm in from the first bracket on the end which panels will pivot from. If using 5 ½ panels, install another bracket 100mm in from the second bracket. Then install a bracket at approximately 400mm intervals.

Opening Width	Track Length	Bracket Quantity	Channel lengths
2000 (1 unit of 2 ½ panels)	1 x 2000	7	1 x 2000
3000 (1 unit of 3 ½ panels)	1 x 3000	9	1 x 3000
4000 (1 unit of 4 ½ panels)	1 x 4000	12	1 x 4000
5000 (1 unit of 5 ½ panels)	1 x 5000	15	1 x 5000
6000 (1 unit of 5 ½ panels)	1 x 6000	17	1 x 6000

If using two units which pivot from both sides of the opening, repeat the 100mm fixing point on both ends of the track.

If using floating panels, increase fixing points in location where panels will be stacked in the open position.

### Application

Suitable for residential or light commercial centre folding partitions.

Panels are hung centrally under the lintel and can fold to one or both sides of the opening.

To cover any width of opening, any number of folding units can be used.

### Panel Specification

Track System:	Centrefold 35
For Individual Panels:	
Max Panel Height	2400mm
Max Panel Weight	35kg
Max Panel Width	920mm
Min Panel Thickness	35mm or 38mm with Flush Bolts

A guide system across the floor must be used on units of 3 and a half panels or more.

Folding units of up to five full panels and one half panel can be hinged to a post.

Floating units consist of five full panels.

Access should be through either a separate door hinged to a post or a door hinged in one of the folding panels.

Panels should be constructed to provide secure fitting for hangers, hinges and guides and can be flush, panelled or glazed.

### Hardware Specification

<b>Track:</b>	100
Material	Aluminium, Mill or Clear Anodised
Standard Lengths	2000mm, 3000mm, 4000mm and 6000mm

<b>Bracket (Face Fix):</b>	1SS/250
Bracket 316 Stainless Steel	

Brackets located close together at the pivot end of the track with other brackets at 400mm centres.

<b>Hanger:</b>	35ENP
----------------	-------

Hanger fitted with nylon tyre wheels on ball race bearings. Vertical adjustment is simple and positive.

<b>Guide:</b>	106SSMF
Stainless steel plate with precision bearing	

<b>Hinge:</b>	282SS
Stainless steel hinge for 19mm minimum panel thickness, 65mm tall, non-mortice	

<b>Channels:</b>	
Aluminium	96W
Finish	Clear Anodised
Standard Lengths	2000mm, 3000mm, 4000mm and 6000mm

<b>Accessories:</b>	
Flush Pull	401
Flush bolt	456

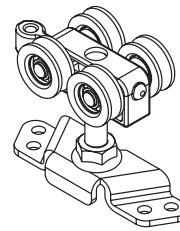

No. 35ENP  
HANGER

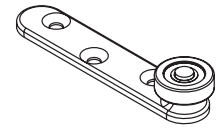

No. 106SSMF  
GUIDE

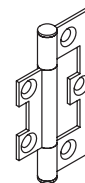

No. 282SS  
HINGE

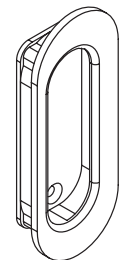

No. 401  
FLUSH PULL

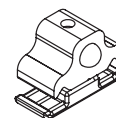

No. 20DS  
DOOR STOP



No. 96W  
CHANNEL

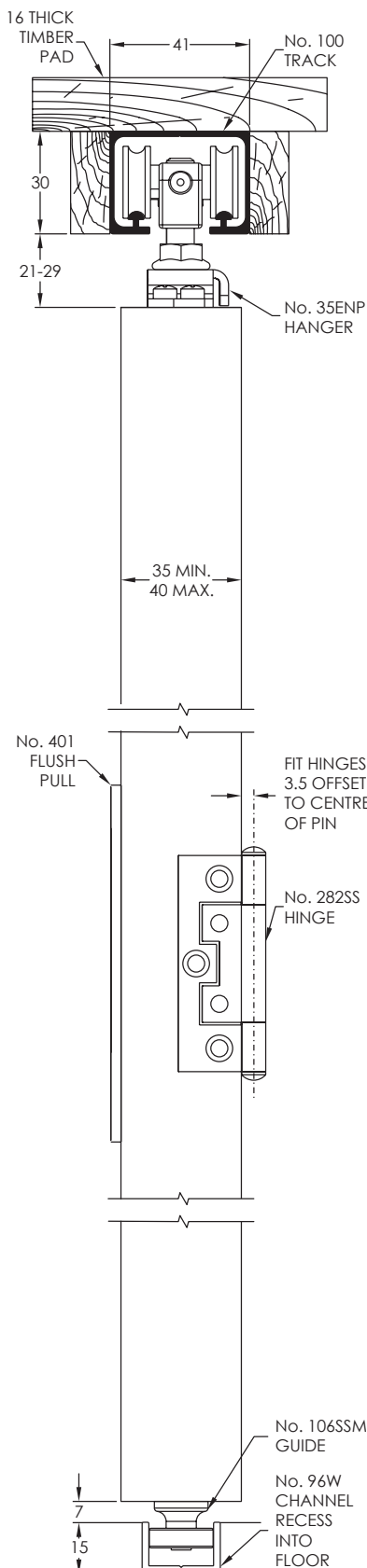

### PANEL PREPARATION

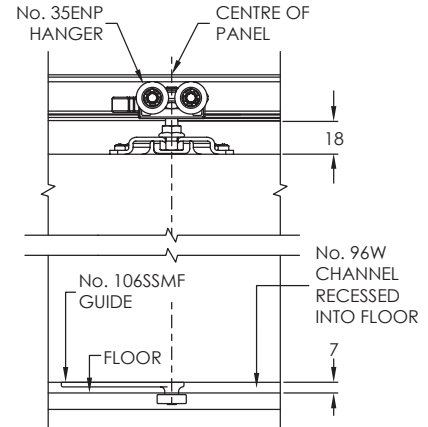
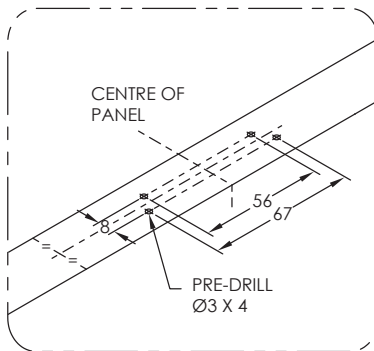

NOTE: IF USING No. 96W CHANNEL & FLUSH BOLTS 38MM MIN PANEL THICKNESS

### 4+1 PANEL SYSTEM - OPEN (SHOWN WITHOUT TRACK, SILL OR HEAD SECTION)

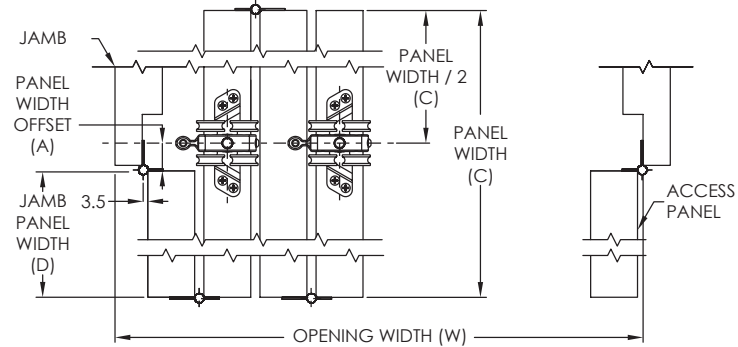

### 4+1 PANEL SYSTEM - CLOSED (TYPICAL ELEVATION)

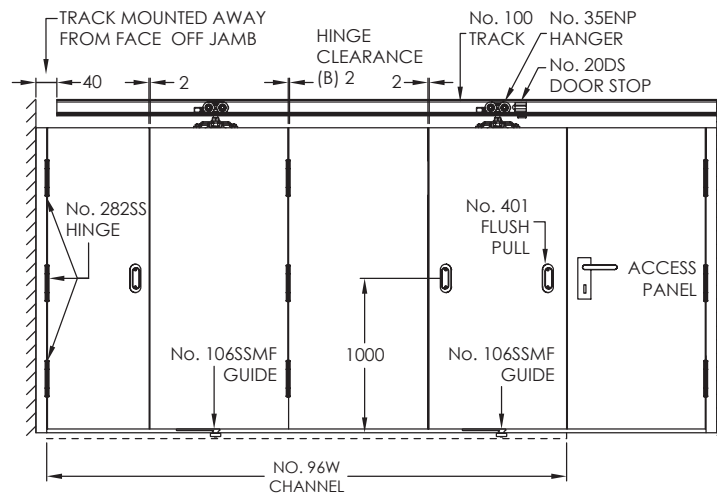

### HINGED TO JAMB - PANEL WIDTH CALCULATIONS

A (PANEL WIDTH OFFSET) =	$\frac{1}{2}$ PANEL THICKNESS + HINGE PIN OFFSET (3.5mm)
B (TOTAL CLEARANCES) =	HINGE CLEARANCE (2mm) X (NUMBER OF PANELS + 1)
C (FULL PANEL WIDTH - FOLDING ONE WAY) =	$\frac{\text{OPENING WIDTH} + A - B}{\text{NUMBER OF FULL PANELS} + 1/2}$
C (FULL PANEL WIDTH - FOLDING TWO WAYS) =	$\frac{\text{OPENING WIDTH} + (A \times 2) - B}{\text{NUMBER OF FULL PANELS}}$
D (JAMB LEAF WIDTH) =	$\frac{\text{FULL PANEL WIDTH (C)}}{2} - A$